

VC-TR60A

Auto Tracking Camera

(PTZ Video Camera)

User Manual - English

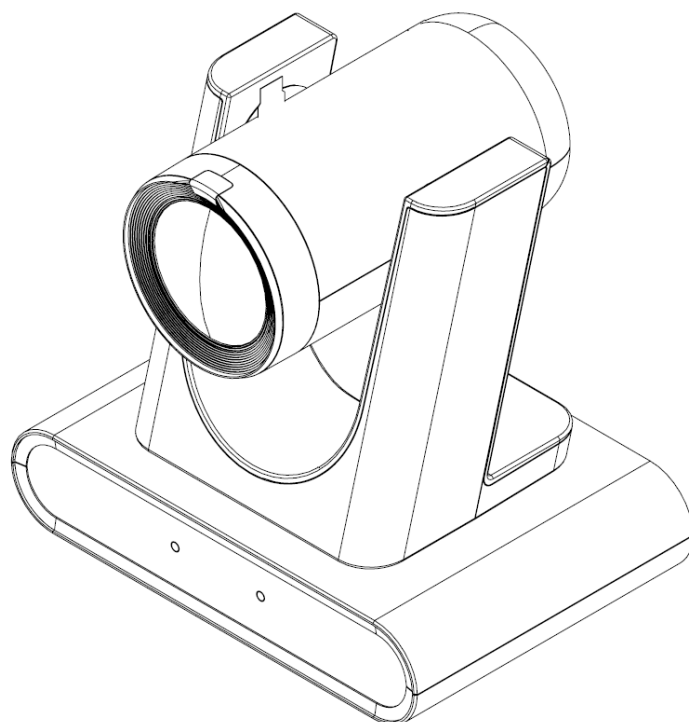

Version VRK100a

To download the latest version of Quick Start Guide,
multilingual user manual, software, or driver, etc.,
please visit Lumens

<https://www.MyLumens.com/support>

Contents

Chapter 1	Package Contents.....	2
Chapter 2	Product Appearance.....	3
	2.1 I/O interface	3
	2.2 LED Indicator.....	3
Chapter 3	Installation Instructions	4
	3.1 Scenario.....	4
	3.2 Preparation before installation.....	4
	3.3 I would like to install the camera on the ceiling/wall/TV stand	5
	3.4 Camera Size	6
	3.5 Connecting Devices	7
Chapter 4	Remote Control and Setting Menu	8
	4.1 Remote Control.....	8
	4.2 Setting Menu	9
Chapter 5	Network setting and Web interface.....	14
	5.1 Connecting Camera to Network	14
	5.2 Web interface functions	16
Chapter 6	Troubleshooting	32
Chapter 7	Safety Instructions.....	33
	Copyright Information	35

Chapter 1 Package Contents

Camera



Power Adapter



Power Cord

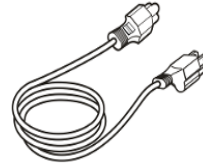

(Appearance may vary depending on country/ region)

3-PIN to 2-PIN connector

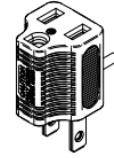

(For Japan only)

USB cable - 2M
(Type B to Type A)



Remote Control



Chapter 2 Product Appearance

2.1 I/O interface

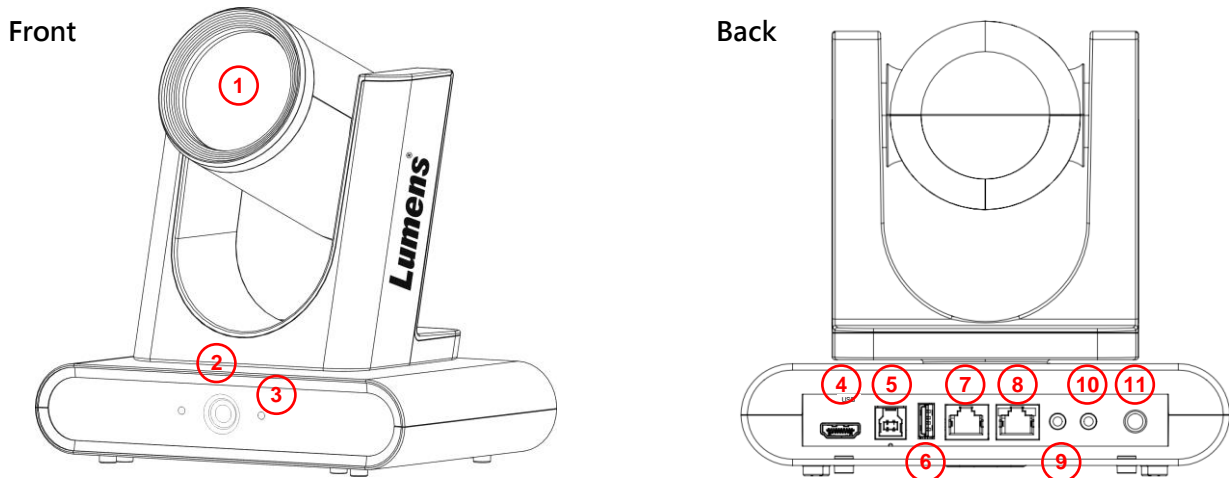

NO.	Item	Function Descriptions
1.	Main camera lens	12x camera lens
2.	Panoramic lens	Panoramic camera lens
3.	LED indicators	Display the camera status, please refer to 2.2 LED Indicator
4.	HDMI Out	HDMI output (Audio output supported)
5.	USB3.0 Out	Connecting to the USB port of the computer and providing USB signal images
6.	Ref USB In	Reference USB2.0 Input helps prevent tracking errors caused by echo from audio equipment.
7.	RS-232/ RS-422 In	RS-232/ RS-422 In, , please refer to 2.3.2 RS-232/ RS-422 Pin Definition
8.	Ethernet port	PoE+ (IEEE802.3at) supported
9.	Ref Audio In	Reference LINE IN helps prevent tracking errors caused by echo from audio equipment.
10.	Line In	3.5mm LINE IN
11.	DC 12V In	DC supply connecting port

2.2 LED Indicator

Status	Power	Standby
Power not connected	No light	No light
Initialization	Green	Orange
Power on (In use)	Green	No light
Standby	No light	Orange
Privacy mode	Orange	No light
Tracking / Framing mode	Green Flickering	Green Flickering

Chapter 3 Installation Instructions

3.1 Scenario

3.1.1 VC-TR60A supported distance range:

- Auto Tracking, Auto Framing: 6-12m
- Voice Tracking: 2-8m

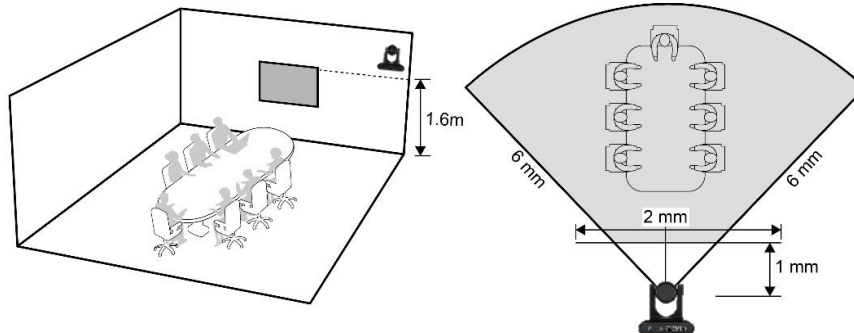

3.1.2 Installation Guidelines

3.1.2.1 We recommend installing the camera on top of a display or suspending it from the ceiling.

Avoid placing on the desktop to prevent obstructing the lens view and audio quality.

3.1.2.2 Auto Tracking/ Framing:

- Avoid having images of people on posters or displays behind the target.

3.1.2.3 Voice Tracking:

- Avoid overlapping people for greater tracking accuracy.
- Keep a clear space in front of the camera (L: 1m, W: 2m) with no obstructions.
- Keep a distance between the table and wall to reduce sound reflections.
- We recommend using acoustic/ sound-absorbing materials in the room.

3.1.2.4 Transporting the Camera:

- Do not grab the camera head when handling the device
- Do not manually rotate the camera head.

Improper rotation may result in damage to the camera.

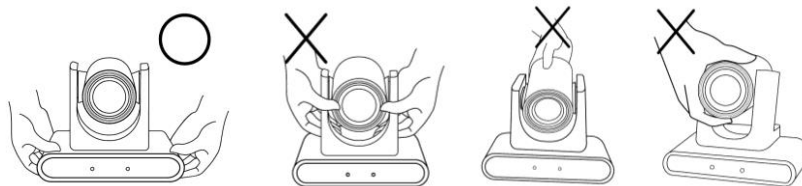

3.2 Preparation before installation

Complete the following steps to ensure that the camera is installed safely and securely.

3.2.1 Never install the device on unstable ceiling or in a place where the device is in danger of falling.

3.2.2 Check whether accessories in the box are complete or not. Please contact the supplier if any item is missing, and make sure to keep the accessories in the box intact.

3.2.3 Choose a proper place for installation of camera. Please use a location that meets the following requirements

- Provides the viewing angle required.
- Avoids bright lights facing towards the camera lens.

3.3 I would like to install the camera on the ceiling/wall/TV stand

Lumens offer following optional accessories.

- VC-WM14 3 in 1 Folding Bracket
- VC-WM15 Ceiling Mounted Bracket

For installation of brackets, please download [Quick Installation Guide](#) from Lumens website

▪ Install on the display

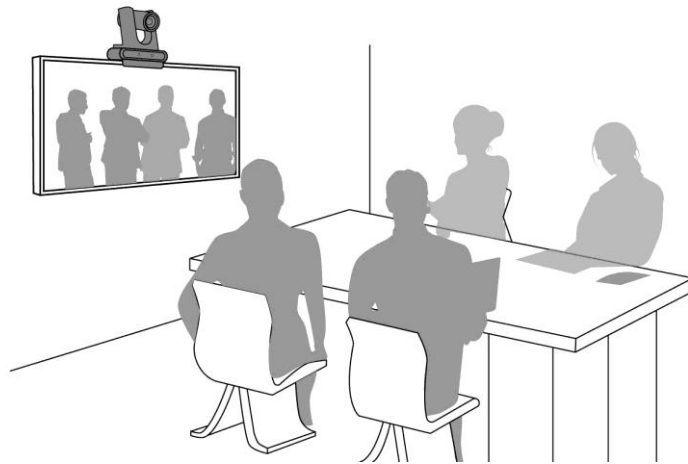

▪ Install on the ceiling

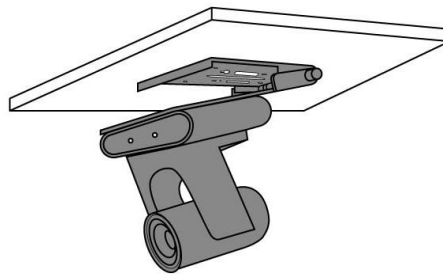

▪ Install on a wall

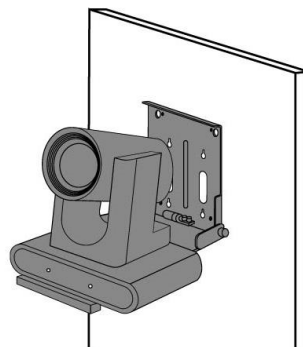

3.4 Camera Size

- Length x Width x Height: 190 x 144x 179mm
- Weight: 1.5Kg

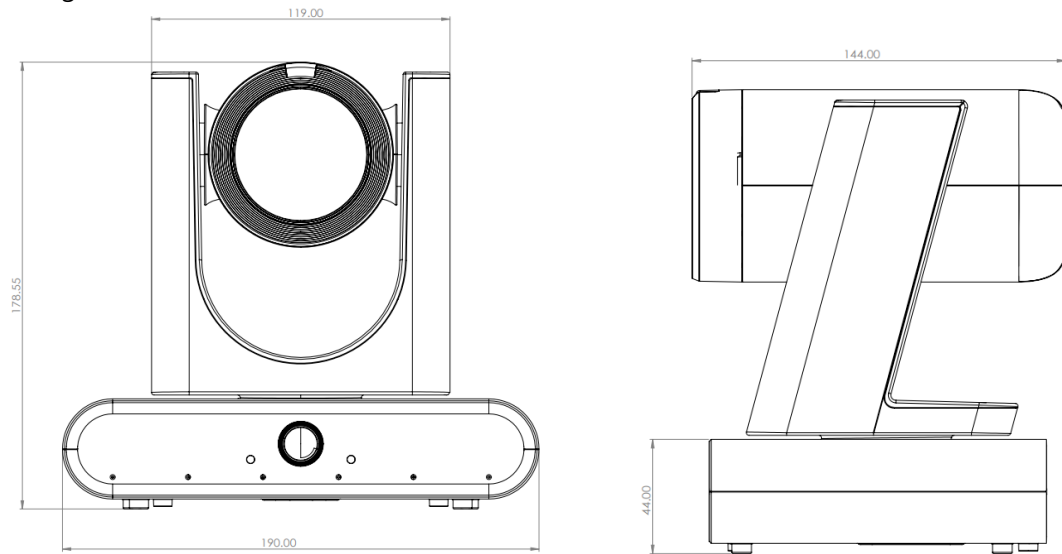

3.4.1 Dimensions of the base unit

The camera can be mounted on a 1/4" -20 UNC PTZ tripod head by using the lock holes on the bottom.

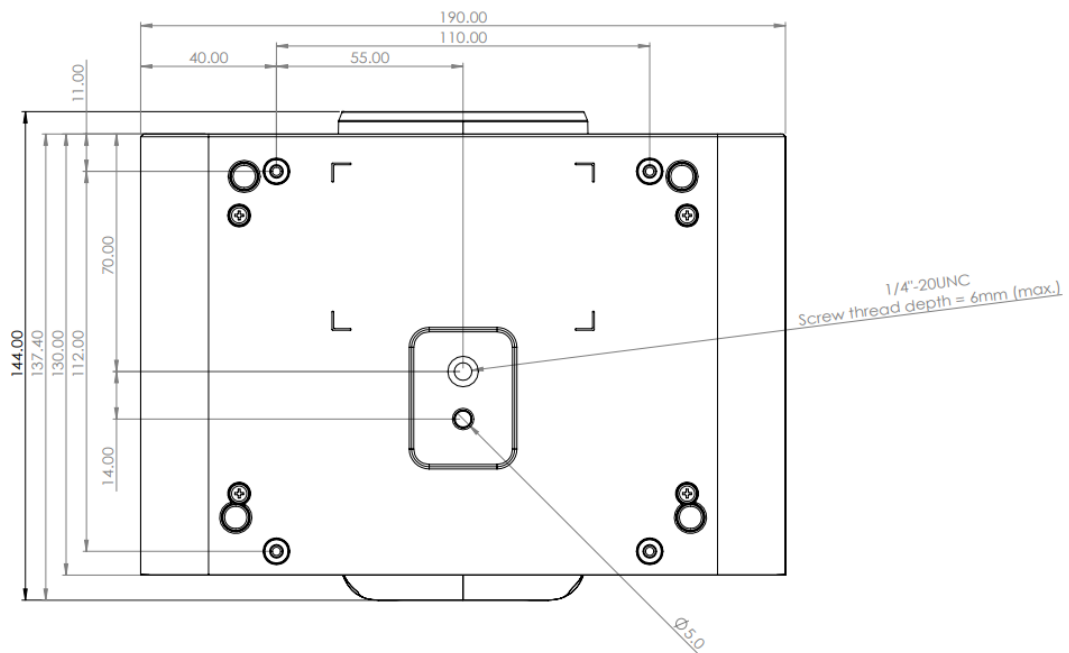

3.5 Connecting Devices

3.5.1 Connecting devices

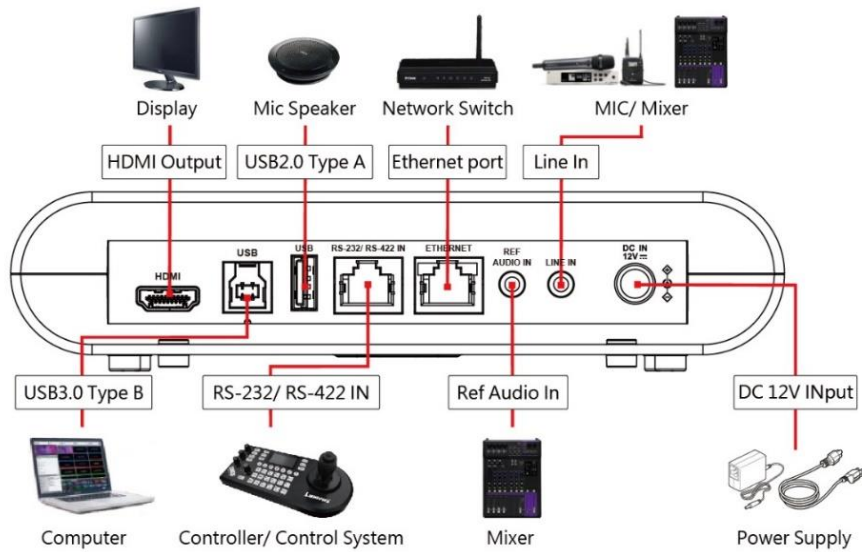

Note Ethernet port supporting PoE+ (IEEE802.3at)

3.5.2 RS-232/RS-422 Pin Definition

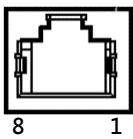

RJ45	IN	Series	RJ45	IN	Series
1	RX_IN-	RS422	5	RX	RS232
2	RX_IN+	RS422	6	DTR	Detection
3	GND	GND	7	TX_IN-	RS422
4	TX	RS232	8	TX_IN+	RS422

Chapter 4 Remote Control and Setting Menu

4.1 Remote Control

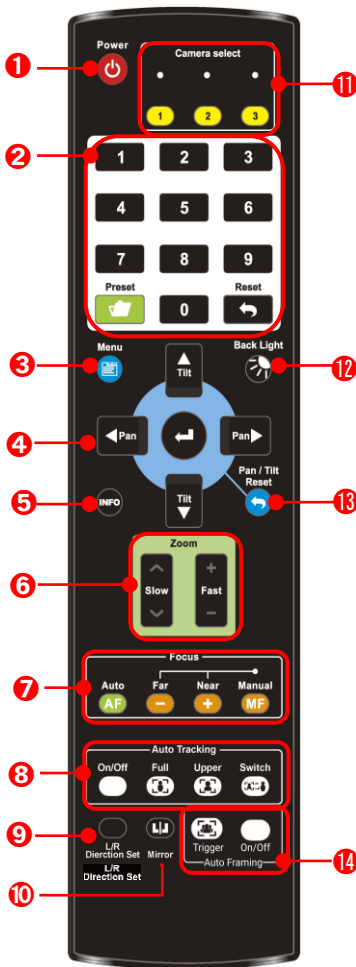

No.	Item	Description
1.	Power	Power on/ off
2.	Preset	<ul style="list-style-type: none"> 0-9: Click to call the preset Preset: Assign a preset number(0~9) to save the current position data Reset: Select a preset number(0~9) to clear the its position data
3.	Menu	Display OSD menu
4.	Pan/ Tilt/ Enter	<ul style="list-style-type: none"> Pan/ Tilt: Move the camera head Home/ Enter: Go back to Home position / Execute
5.	Info	Status information
6.	Zoom	<ul style="list-style-type: none"> Fast: High speed zoom Slow: Low speed zoom
7.	Focus	<ul style="list-style-type: none"> Auto: Auto focus Manual: Enable Manual Focus Far/ Near: Adjust the focus in Manual mode
8.	Auto Tracking	<ul style="list-style-type: none"> On/Off: Enable/Disable Auto Tracking Full: Frames presenter' s full body Upper: Frames presenter' s torso Switch: Switch target to a different presenter
9.	L/R Direction Set	L/R Direction / Normal
10.	Mirror	Rotate the image (OFF / Mirror / Flip / Rotate)
11.	Camera select	Choose Camera 1 ~ 3
12.	Back Light	Turn on/off back light compensation
13.	Pan/Tilt Reset	Clear the Pan/Tilt setting
14.	Auto Framing	<ul style="list-style-type: none"> On/Off: Activate voice tracking/ auto framing according to the [Tracking Mode] set on the webpage. Trigger: Manual Framing correction. (In Auto Framing mode.)

4.2 Setting Menu

Press [MENU] on the remote control. Default is indicated in **bold**.

Layer 1	Layer 2	Layer 3	Description
Exposure	Mode	Full Auto / Shutter Pri/ Iris Pri/ Manual/ White Board	Exposure mode setting
	Spot Light	On/ Off	Turn on/ off Spot Light
	Spot Light Position	X(0~5)Y(0~3)	Adjustable after Spot Light is activated
	Anti-flicker	50Hz/ 60Hz/ Off	Activate the anti-flicker function to eliminate flicker from lighting.
	Exposure Comp.	On/ Off	Turn on/off Exposure Compensation.
	Exposure Comp. Level	-7~ C ~7	Adjustable after Exposure Compensation is activated
	Shutter Speed	1/10000~1/1	Adjustable when the Exposure mode is set to Shutter Pri or Manual
	Iris Level	F1.6~ C ~F14/ Off	Adjustable when the Exposure mode is set to IRIS Pri or Manual
	Gain Limit	8~ 30 dB	Max. limit value of electron gain
	Gain Level	0 ~30dB	Adjustable when the Exposure mode is set to Manual
	WDR	Off / 1/ 2/ 3/ 4/ 5	WDR settings
White Balance	Mode	1.Auto 2.Indoor 3.Outdoor 4.One Push WB 5.ATW 6.Manual 7.Sodium Lamp	Select the color temperature 1. 4000k ~ 7000k 2. 3200k 3. 5800k 4. 1700k ~ 10000k 5. 1700k ~ 10000k 6. 自定义 7. 2800k
	One Push Trigger	ENTER	One push trigger
	Manual Red	0~ C ~127	Adjustable when the white balance mode is set to Manual
	Manual Blue	0~ C ~127	Adjustable when the white balance mode is set to Manual
Picture	2D NR	Off/ 1~ C ~7	2D noise reduction
	3D NR	Off/ 1~ C ~7	3D noise reduction
	Image Mode	Default / Custom	Users can customize the selected image mode

Layer 1	Layer 2	Layer 3	Description
	Brightness	0~ <u>C</u> ~14	Adjustable when Image Mode set to Custom
	Hue	0~ <u>C</u> ~14	Adjustable when Image Mode set to Custom
	Saturation	0~ <u>C</u> ~14	Adjustable when Image Mode set to Custom
	Gamma	0~ <u>C</u> ~4	Adjustable when Image Mode set to Custom
	Sharpness	0~ <u>C</u> ~11	Adjustable when Image Mode set to Custom
Tracking	Type	Voice Tracking / Auto Tracking/ Auto Framing	
Pan Tilt Zoom)	Pan/Tilt Limit	On/ Off	Disable/ Enable the angle limit setting
	Pan Right Limit	0~ <u>170</u>	Limit the panning angle (right side)
	Pan Left Limit	<u>-170</u> ~0	Limit the panning angle (left side)
	Tilt UP Limit	0~ <u>90</u>	Limit the tilt angle (up)
	Tilt Down Limit	<u>-30</u> ~0	Limit the tilt angle (down)
	Pan Flip	On/ Off	Reverses the Pan direction
	Tilt Flip	On/ Off	Reverses the Tilt direction
	Preset Speed	5/ 25/ 50/ 80/ <u>120</u> deg/sec	Set the robotic and zoom speed of the camera
	PTZ Speed Comp	On/ Off	Enable the zoom speed independent from the robotic speed
	D-Zoom Mode	<u>x1</u> ~x16	Set the digital zoom limit
D-Effect	Mirror	Off / Mirror/ Flip/ Mirror+Flip	Activate image rotation and/or mirroring
Auto Focus	AF Sensitivity	Low/ Middle / High	Changes the sensitivity of the auto-focus.
	AF Frame	Center/ Full Frame/ Auto	Changes the focusing zone to the selected mode.
Ethernet	DHCP	On / Off	Enable/Disable dynamic host configuration
	IP Address	<u>192.168.100.100</u>	Configurable when DHCP is set to Off
	Subnet mask	<u>255.255.255.0</u>	
	Gateway	<u>192.168.100.254</u>	
Audio	Audio Enable	On/ Off	Turn on/off audio output

Layer 1	Layer 2	Layer 3	Description
	Audio In	<u>Line In</u>	
	Audio Volume	0~ <u>C</u> ~10	Volume Setting
	Audio Delay	On/ <u>Off</u>	When the audio is not synchronized with the video, enable this function to set the audio delay time
	Audio Delay Time(ms)	<u>-10</u> ~-500ms	Set audio delay time
	Encode Sample Rate	<u>48</u> KHz(AAC)	Set the encode type and sample rate
System	Prompt	On/ <u>Off</u>	Turn on/off the prompt information on the display
	IR Receive	<u>On</u> / Off	Turn on/off the infrared reception When it is Off, the remote control will not be able to control the camera. Disconnect and then plug the power cable to re-activate remote control.
	IR Select	<u>1</u> / 2/ 3	Match the remote control's IR setting with the camera's IR setting.
	Tally Lamp	On/ <u>Off</u>	Enables the camera's tally light.
	Tally CMMD Mode	Normal/ <u>Link</u>	Set whether the tally lamp is linked with RS232 commands. <ul style="list-style-type: none"> ▪ Normal (Not linked): The tally lamp and mode are set separately. <ul style="list-style-type: none"> ➤ When the tally lamp is on but the default mode is off, an additional command is required to set the indicator light mode ➤ When the tally lamp is off, setting the mode will not trigger the indicator light ▪ Link: <ul style="list-style-type: none"> ➤ When the tally lamp is on, the default mode is a red light ➤ When the tally lamp is off, setting the mode will turn on the tally lamp.

Layer 1	Layer 2	Layer 3	Description
	PIP	On/ <u>Off</u>	Activate PiP, set the sub-screen size and position. Note Motionless Switch cannot be activated when PIP is enabled
	Mode Select	Auto Switch/ <u>PTZ</u> / Panoramic	Auto Switch is only available when Voice Tracking is enabled.
	Size	Small/ Normal/ Large	Set sub-screen size
	Position	Bottom-R/ Bottom-L/ Upper-R/ Upper-L	Set sub-screen display position
	Tracking Led Status	On/ <u>Off</u>	When enabled, LED on the front panel will flash green while the camera is tracking.
	Language	<u>English</u> / 中文	
	Initial Position	<u>Last MEM</u> / 1st Preset	After turning on the camera, you can select the lens to be returned to <u>Last MEM</u> or 1st Preset Note 1st Preset = Preset 0
	Montionless Switch	On/ <u>Off</u>	When switching, the camera will utput to the panoramic view, and once the PTZ movement is completed, it will revert to the close-up view. Note Applicable for Voice Tracking only
	Motionless Preset	On/ <u>Off</u>	The image will freeze when Preset is executed. Freeze will be released after Preset is completed
	Privacy Mode	On/ <u>Off</u>	When the camera is turned off via the remote control or software, the lens will automatically turn to the bottom right to ensure the user' s privacy
	Protocol	<u>VISCA</u>	Supports VISCA protocol
	Baud Rate	9600/38400	Transmission speed of the control signal
	VISCA Address	<u>1</u> ~7	The camera ID address can be assigned.
	USB 4K Mode	On/ <u>Off</u>	Supports 4K (2160p 25/30) output over USB. Note <ul style="list-style-type: none"> ■ Stream 1 is limited to 1080p when USB 4K mode is selected. ■ After changing resolution, the camera will restart. The browser will need to be refreshed.

Layer 1	Layer 2	Layer 3	Description
	Output Mode	2160P 60/50/30/25 <u>1080p 60</u> /50/30/25 720p 60/50 1080i 60/50	Set the output resolution
	Factory Reset	On/ <u>Off</u>	Resume the factory default setting
Status			Display the current setting information

Chapter 5 Network setting and Web interface

5.1 Connecting Camera to Network

5.1.1 Connection

Two common connection methods are shown below

1. Connect via switch or router

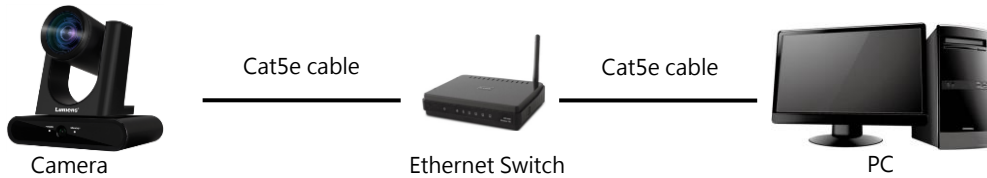

2. Connect directly via an Ethernet cable, and the computer's IP address must be modified to match the network segment used by the camera.

E.g.: the camera's default IP address is 192.168.100.100, the computer's IP address should be set to the same segment, such as 192.168.100.101, to connect properly to the camera.

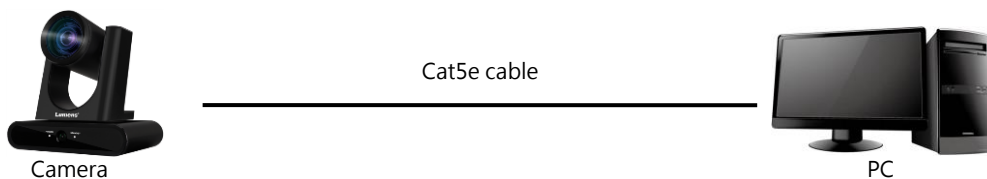

- Modify the computer's network settings

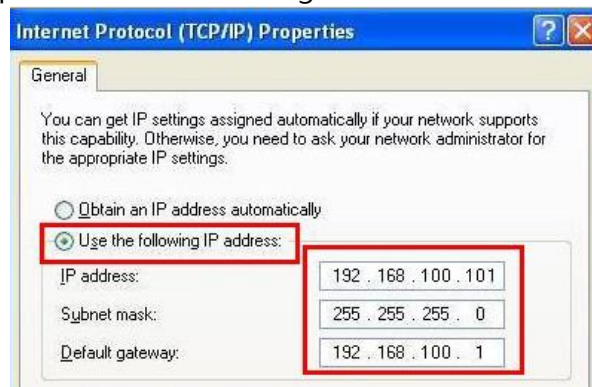

5.1.2 Use a Browser to view Images

- Open the browser, and enter the IP address of the camera in the address bar
E.g.: <http://192.168.100.100> (default IP address)

- Enter the Username and Password

Note For the first-time login, please refer to [5.2.10 System-User](#) to change the default password



Lumens IP Camera

- Account: admin
- Password: 9999

5.1.3 Use a RTSP Player to View Images

Free software can be used for RTSP connection, such as VLC, Quick Time and PotPlayer. RTSP connection address formats are as follows:

- RTSP Stream 1 => <rtsp://camera IP:8557/h264>
- RTSP Stream 2 => <rtsp://camera IP:8556/h264>
- Panoramic Lens View => <rtsp://camera IP:8553/h264>

If password authentication is enabled, the RTSP connection address is as follows:

- <rtsp://Username:Password@VC IP address:port/h264>
- To enable password authentication function, please refer to [5.2.8 System-Network](#)

Example:

Open the VLC software, click [Open Network Streaming], and enter the URL:

<rtsp://192.168.100.150:8557/h264>

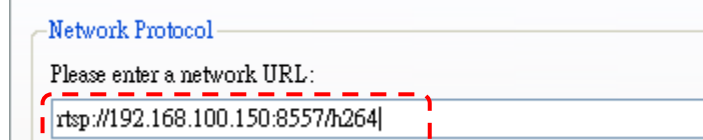
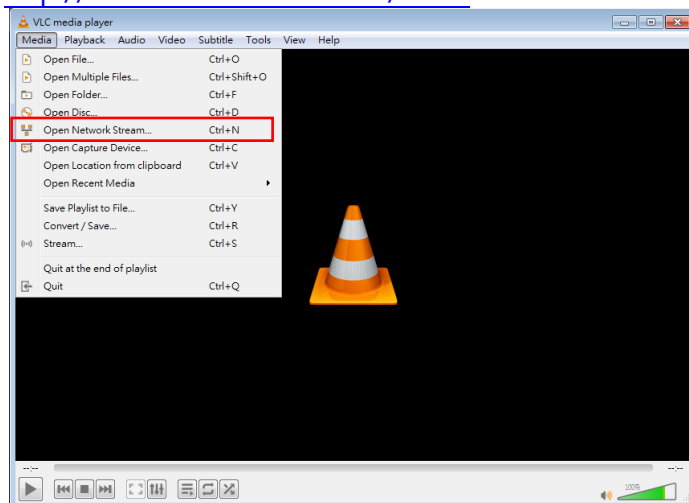

5.2 Web interface functions

5.2.1 Login

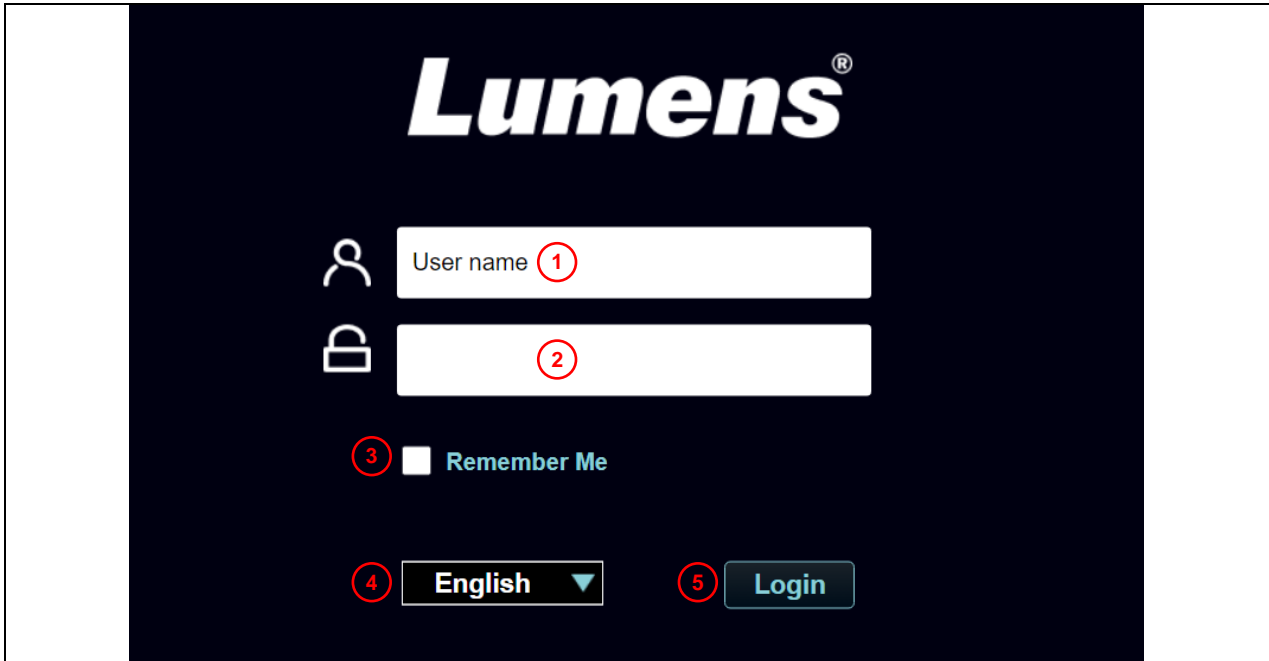





No	Item	Function Descriptions
1	User name	Enter user login account (default: admin)
2	Password	Enter user password (default: 9999) <small>Note</small> For the first-time login, please refer to 5.2.10 System-User to change the default password
3	Remember Me	Save user name and password. When you log in next time, there is no need to re-enter them.
4	Language	Supporting English/ Traditional Chinese/ Simplified Chinese
5	Login	Log in to the web interface.

5.2.2 Live View

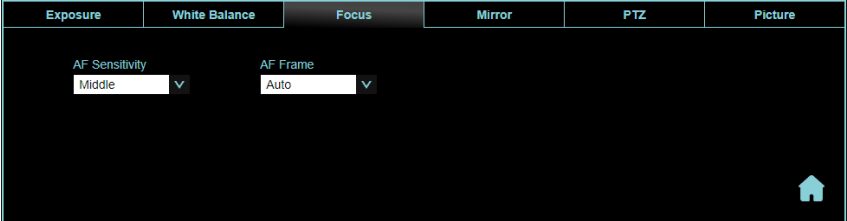

No	Item	Function Descriptions
1	Camera ID/ Location	Display camera ID/ Location Please refer to 5.2.7 System-Output
2	Preview screen	Display the current view of the camera
3	Preset setting	Select the number first and then select Store or Load
4	Pan/Tilt	Adjust the Pan/Tilt position of the camera
5	Zoom	Zoom In/Zoom Out
6	AF/ MF	Switch Auto Focus/ Manual Focus.
7	Pan/ Tilt Speed	Adjust the pan/ tilt speed
8	Zoom speed	Adjust the zoom speed
9	Tracking	Enable/ Disable Voice Tracking/ Auto Tracking/ Auto Framing
10	Camera Setting	Please refer to 5.2.3 Live View - Camera Setting for related settings

5.2.3 Live View - Camera Setting

No	Item	Function Descriptions
		
1.	Exposure	<ul style="list-style-type: none"> ■ Mode: Exposure mode (Full Auto/ Shutter Pri/ Iris Pri/ Manual/ White Board) ■ Gain Limit: Adjust gain limit (adjustable under “Manual” mode.) ■ Exposure Comp. Level: Select exposure compensation level ■ WDR: Set the level to change the dynamic range of the picture. ■ Iris Level: Adjust the aperture (adjustable under “Manual” or “Iris Pri” mode) ■ Shutter Speed: Adjust the shutter speed (adjustable under “Manual” or “Shutter Pri” mode) ■ Anti-Flicker: Activate the anti-flicker function to eliminate flicker from lighting.
2.	White Balance	 <ul style="list-style-type: none"> ■ Mode: Select the color temperature ■ One Push: Executes a one time color temperature adjustment (configurable in [One Push WB] mode) ■ Manual Red/Blue: Manually adjust red/blue color temperature
3.	Focus	 <ul style="list-style-type: none"> ■ AF Sensitivity: change the sensitivity of the auto focus. ■ AF Frame: Changes the focusing zone to the selected mode.
4.	Mirror	 <ul style="list-style-type: none"> ■ Mirror: Set image mirroring ■ Flip: Set image flip

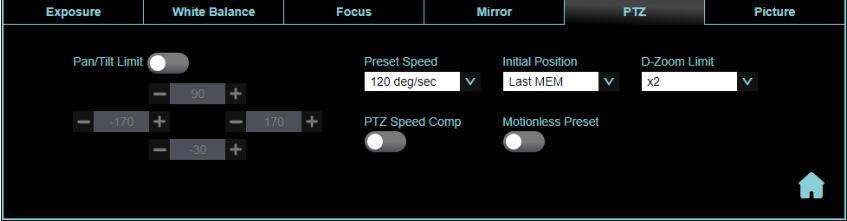
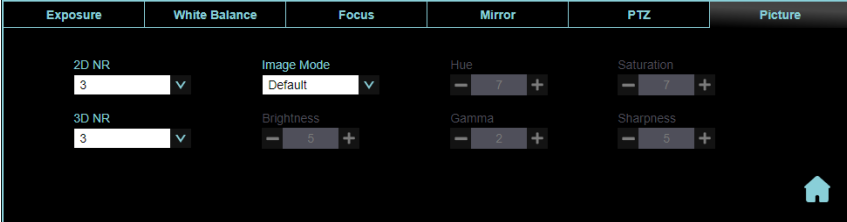
5.	Pan Tilt Zoom	 <ul style="list-style-type: none"> ■ Pan/Tilt limit: Enable to set the pan/tilt range limit ■ Preset Speed: Set the rotation speed when a Preset executed ■ Initial Position: Set the camera go to the Last MEM or 1st Preset position after POWER ON ■ Note 1st Preset = Preset 0 ■ PTZ Speed Comp: The Pan/Tilt robotic speed will vary according to the zoom position ■ Motionless Preset: Image will freeze when a preset is activated. Freeze will be released after Preset completed
6.	Picture	 <ul style="list-style-type: none"> ■ 2D noise reduction: 2D noise reduction settings ■ 3D noise reduction: 3D noise reduction settings ■ Image Mode: Users can customize the image mode ■ Hue: Adjustable when Image Mode set to Custom ■ Saturation: Adjustable when Image Mode set to Custom ■ Brightness: Adjustable when Image Mode set to Custom ■ Gamma: Adjustable when Image Mode set to Custom ■ Sharpness: Adjustable when Image Mode set to Custom
7.	PTZ Control	Go back to PTZ Control page

5.2.4 Tracking

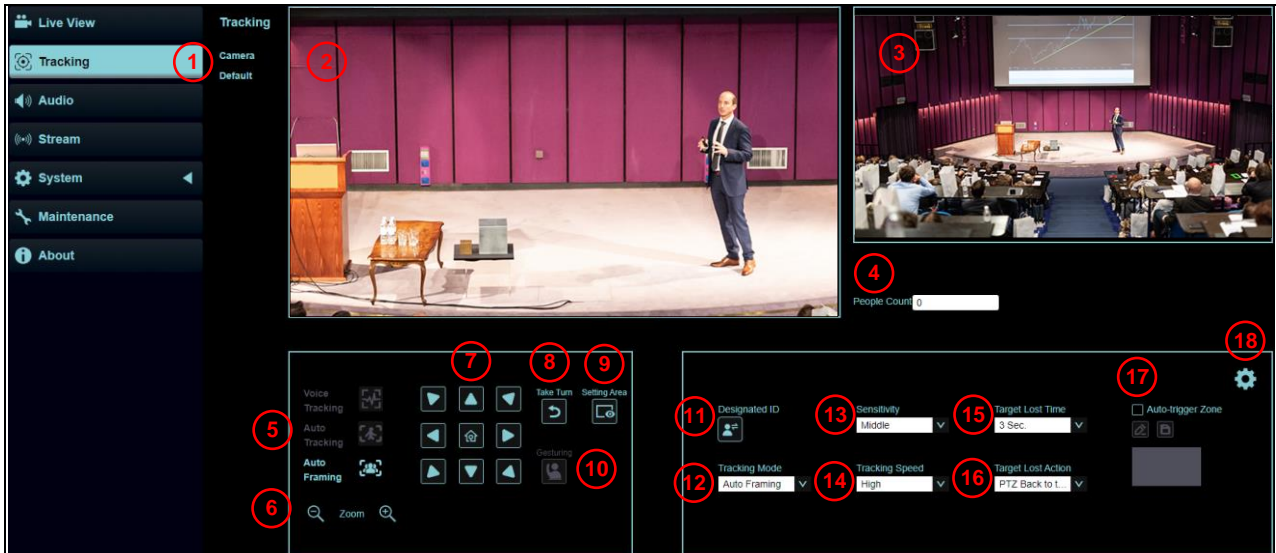

No	Item	Function Descriptions
1.	Camera ID/Location	Display camera ID/ location. Please refer to 5.2.7 System-Output
2.	PTZ preview screen	Display the current view of the main lens.
3.	Panoramic preview screen	Display the current view of the panoramic lens
4.	People Count	Display the calculated number of people in the screen.
5.	Tracking	Enable/ Disable Voice Tracking/ Auto Tracking/ Auto Framing <div style="border: 1px solid gray; padding: 2px; margin: 5px 0;">Note</div> <ul style="list-style-type: none"> ▪ Select Voice Tracking, Auto Tracking or Auto Framing. ▪ Not applicable with [Center Stage] mode
6.	Zoom	Zoom In/Zoom Out image
7.	Pan/ Tilt	Adjust the Pan/Tilt of the camera <div style="border: 1px solid gray; padding: 2px; margin: 5px 0;">Note</div> PTZ setting is not supported when tracking function enabled.
8.	Take turn	Switch the target. <div style="border: 1px solid gray; padding: 2px; margin: 5px 0;">Note</div> Applicable for [Auto Tracking] mode only
9.	Setting Area	Display the configured tracking and blocked areas in the panoramic preview screen. <div style="border: 1px solid gray; padding: 2px; margin: 5px 0;">Note</div> Applicable for [Auto Tracking] mode only
10.	Gesturing	The tracking target will automatically switch when a speaker raises both hands.  <div style="border: 1px solid gray; padding: 2px; margin: 5px 0;">Note</div> Applicable for [Auto Tracking] mode only
11.	Designated ID	Display individuals the camera has detected. Target ID can be switched by clicking on a subject with the mouse. <div style="border: 1px solid gray; padding: 2px; margin: 5px 0;">Note</div> Not applicable for [Center Stage] mode
12.	Tracking Mode	Set the Tracking Mode <ul style="list-style-type: none"> ▪ Voice Tracking: Voice Tracking

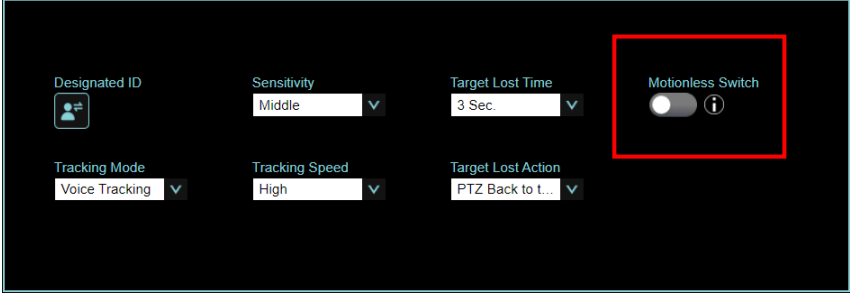
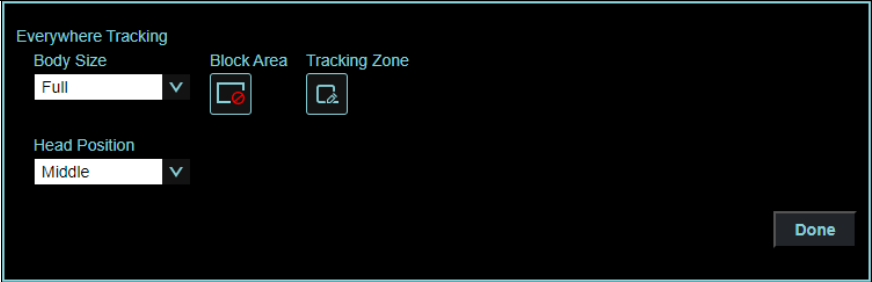
		<ul style="list-style-type: none"> ▪ Auto Tracking: Everywhere Tracking/ Stage Tracking/ Partition Tracking ▪ Center Stage ▪ Auto Framing: Auto Framing/ Partition Framing
13.	Sensitivity	Set tracking sensitivity
14.	Tracking Speed	Set tracking speed
15.	Target Lost Time	Set a delay to take action after a tracking target is lost
16.	Target Lost Action	Set the action after a tracking target is lost
17.	Auto-trigger zone	<p>After a person enters the area for 3 seconds, tracking/ framing will be triggered.</p> <p>Note</p> <ul style="list-style-type: none"> ▪ [Tracking Mode]> [Center Stage] is not supported. ▪ Enabling Auto Tracking/ Auto Framing will disable the [Auto-trigger zone] function. ▪ Stopping Auto Tracking/ Auto Framing will reactivate the [Auto-trigger zone] function.
18.	Motionless Switch	 <p>When switching, the camera will go to the panoramic view, and once the PTZ movement is completed, it will revert to the close-up view.</p> <p>Note Applicable for Voice Tracking only</p>
19.	Tracking Mode Setting	Advanced settings for tracking.
19.1	Everywhere tracking	 <ul style="list-style-type: none"> ■ Body Size: Set Full/ Half Body ■ Head Position: Set the head position of the person in the screen ■ Block Area: Click the left mouse button to draw a frame on the panoramic view to set a blocked area. ■ Tracking Zone: Click the left mouse button to draw a frame on the panoramic view to set a designated tracking area.

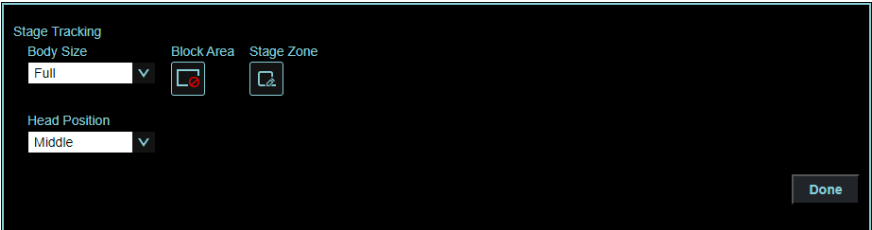
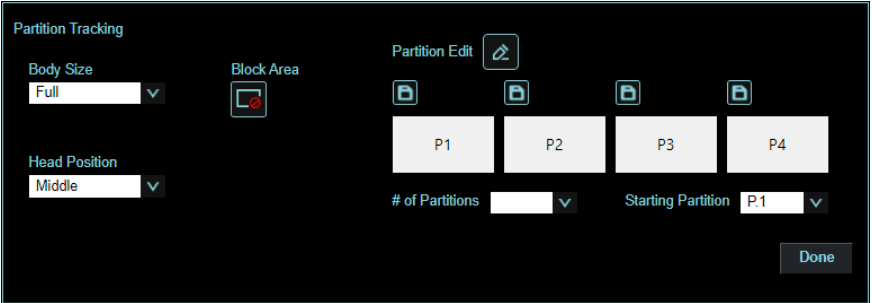
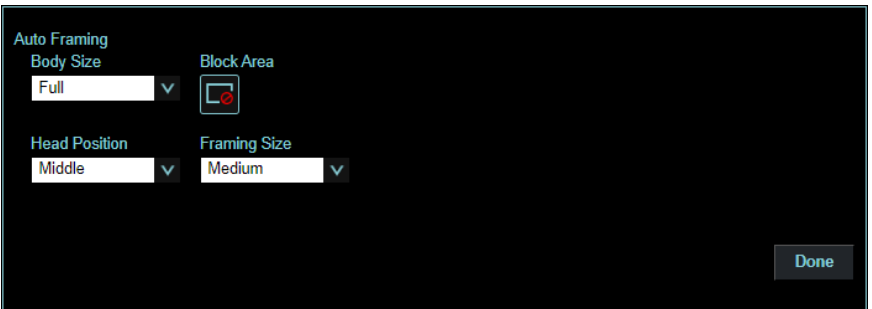
19.2	Stage Tracking	 <ul style="list-style-type: none"> ■ Body Size: Set Full/ Half Body ■ Head Position: Set the head position of the person in the screen ■ Block Area: Click the left mouse button to draw a frame on the panoramic view to set a block area. ■ Tracking Zone: Click the left mouse button to draw a frame on the panoramic view to set a designated tracking area.
19.3	Partition Tracking	<p>Set Partition Tracking. Up to 4 zones can be set When a person enters the specific zone, the camera switches to the partition. Tracking will not be performed within the zone, while outside the zone, everywhere tracking will be active.</p>  <ul style="list-style-type: none"> ■ Head Position: Set the head position of the person on the screen ■ Block Area: Click into the Edit mode, frame by holding the left mouse button and set the blocked area ■ Block Area: Click the left mouse button to draw a frame on the panoramic view to set a blocked area. ■ Partition Edit: Edit and save partition positions ■ # of Partition: Set the number of partitions. ■ Starting Partition: Set the starting zone position (the first zone the camera tracks).
19.4	Auto Framing	 <ul style="list-style-type: none"> ■ Head Position: Set the head position of the person on the screen

		<ul style="list-style-type: none"> ■ Block Area: Click into the Edit mode, frame by holding the left mouse button and set the block area ■ Block Area: Click the left mouse button to draw a frame on the panoramic view to set a block area. ■ Framing Size: Set the framing size.
19.5	Partition Framing	<div data-bbox="555 376 1423 678" style="border: 1px solid black; padding: 5px;"> </div> <ul style="list-style-type: none"> ■ Partition Edit: Edit and save partition positions ■ # of Partition: Set the number of partitions.

5.2.5 Audio

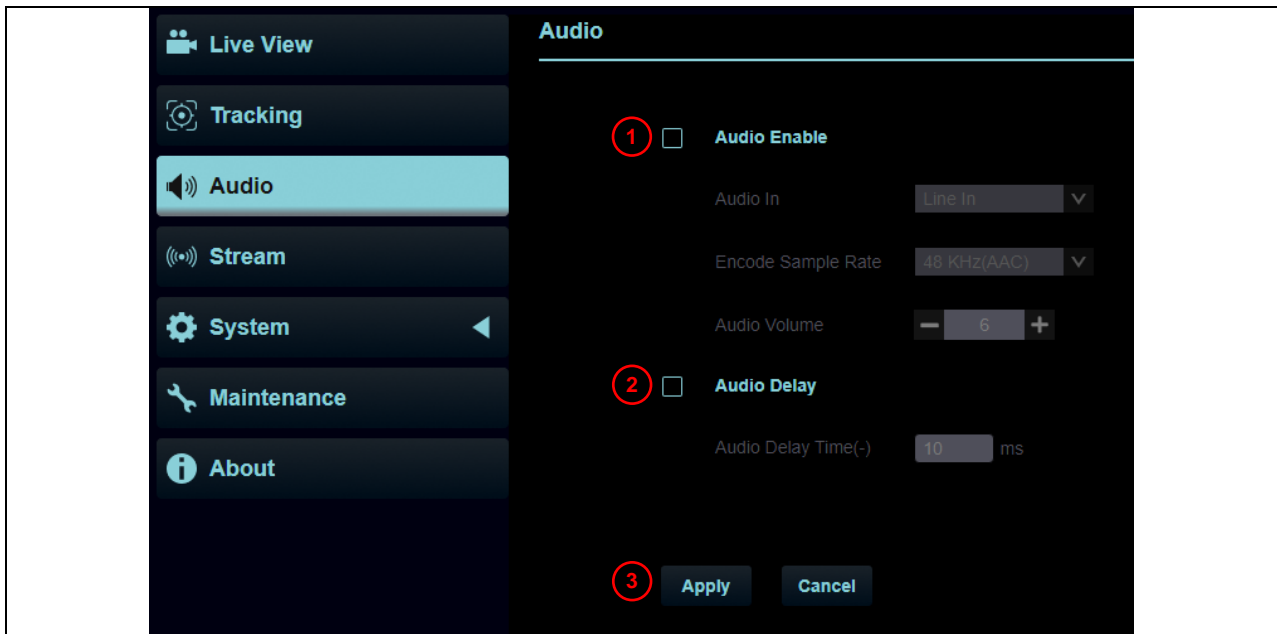

No	Item	Function Descriptions
1	Audio Enable	Select to enable Audio function <ul style="list-style-type: none"> ■ Audio In: Set Line In ■ Encode sample rate: Encode type and sample rate (48KHz(AAC)) ■ Volume: Adjust Audio Volume
2	Audio Delay	Check to set the audio delay time (10 ~ -500 ms)
3	Apply/Cancel	Apply/ Cancel Audio Settings

5.2.6 Stream

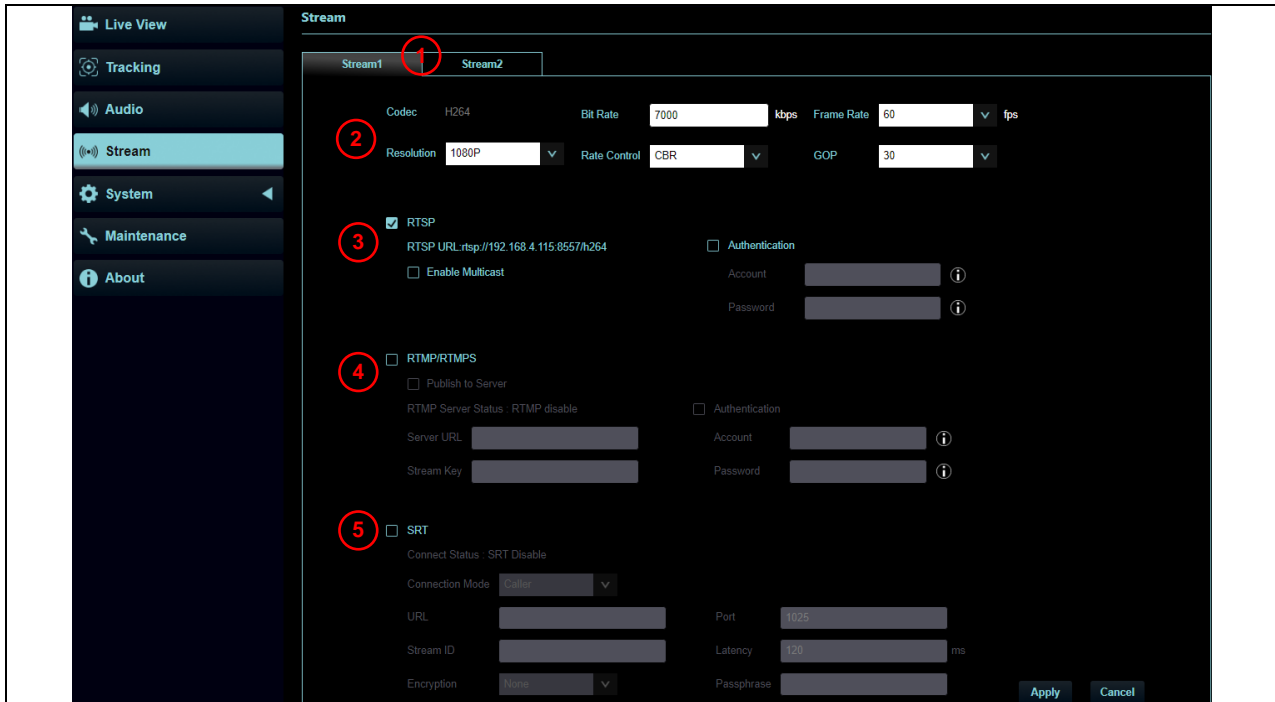

No	Item	Function Descriptions
1	Streaming 1/ 2	Supporting 2 streaming outputs
2	Streaming parameter settings	Please refer to 5.2.6.1 Streaming Parameter Setting .
3	RTSP	<p>Select to enable RTSP</p> <ul style="list-style-type: none"> ■ Enable/ Disable Multicast Multicast is recommended when the stream is being watched by more than 4 viewers.. ■ Enable/Disable Password Authentication <ul style="list-style-type: none"> ➢ Please refer to 5.1.3 Using RTSP Player to View the Images for the connection format. ➢ The username/ password is the same as the web login password of the camera, please refer to 5.2.10 System Settings - User to add/modify account information
4	RTMP/ RTMPS	<p>Use the RTMP URL provided by the RTMP service platform to publish the camera live view to the platform.</p> <ul style="list-style-type: none"> ■ For YouTube streaming, please refer to 5.2.5 Audio to turn on the audio function
5	SRT	<ul style="list-style-type: none"> ■ Check to enable and set SRT streaming After the SRT streaming is opened, it will be connected automatically upon camera startup. ■ The port number must be set in the range above 1024 with a maximum value of 9999 <p>Note The following ports are used by the camera. Setting the ports may result in connection issues. 8554, 8556, 8557, 8080, 9090, 1935</p>

		<ul style="list-style-type: none"> Latency can be set between 20-8000 microseconds. (Default is 120 microseconds)
--	--	--

5.2.6.1 Streaming parameter setting

Function		Streaming 1	Streaming 2
Encode Format		H.264	H.264
Resolution		4K/ 1080p / 720p	720p
Bit rate	Bit rate	2,000~20,000	2,000~20,000
	Default	7,000	3,000
Rate Control		CBR / VBR	
Frame Rate/ Group of Pictures		Setting according to the supported resolution	

5.2.7 System - Output

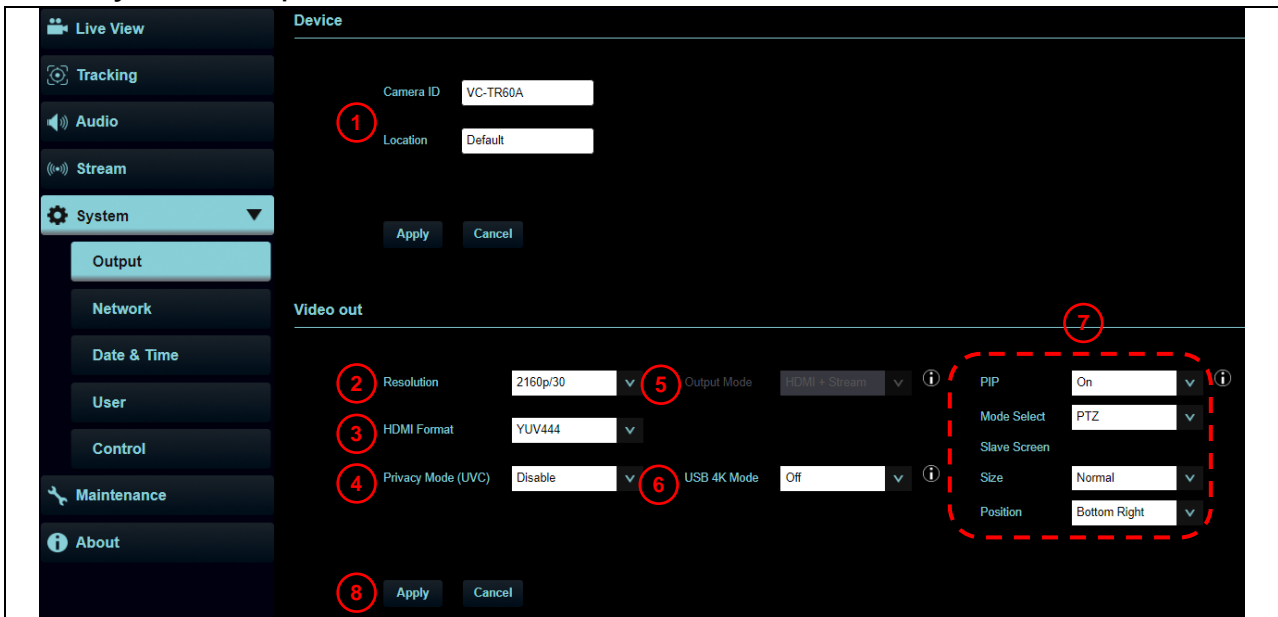

No	Item	Function Descriptions
1	Camera ID/ Location	Name camera ID/ Location <ul style="list-style-type: none"> Supporting 1 - 32 characters for the camera ID/ location Supporting English, Chinese and numbers. Special symbols such as "/" and "space" cannot be used <p>Note: Modifying this field will also update the ONVIF device name/location.</p>
2	Resolution	Set the resolution of the camera <p>Note: After changing resolution, the camera will restart. The browser will need to be refreshed.</p>
3	HDMI Format	Supporting YUV422/ YUV444 / RGB
4	Privacy Mode (UVC)	After the privacy mode is enabled, when the camera is turned off via the remote control or software, the lens will automatically turn to the bottom right to ensure the user's privacy.
5	Output Mode	Select HDMI+Stream or HDMI+UVC output <p>Note:</p> <ul style="list-style-type: none"> HDMI, Stream and USB cannot output simultaneously at 2160p 50/60 resolution. When using 4K resolution, the UVC outputs 1080p resolution.
6	USB 4K Mode	Supports 4K (2160p 25/30) output over USB. <p>Note:</p> <ul style="list-style-type: none"> Stream 1 is limited to 1080p when USB 4K mode is selected. After changing resolution, the camera will restart. The browser will need to be refreshed.
7	PIP	Once PIP enabled, the mode, sub-screen size and position can be set. <p>Note:</p> <ul style="list-style-type: none"> Support following resolutions. HDMI: 2160p 30/25、 1080p 60/50/30/25 UVC: 1080p 60/50/30/25 [PIP] and [Motionless Switch] in Voice tracking mode cannot be

		<p>used simultaneously.</p> <ul style="list-style-type: none"> Once PIP is enabled, [Motionless Switch] will be automatically disabled.
8	Apply/ Cancel	Apply/ Cancel Setting

5.2.7 System - Network

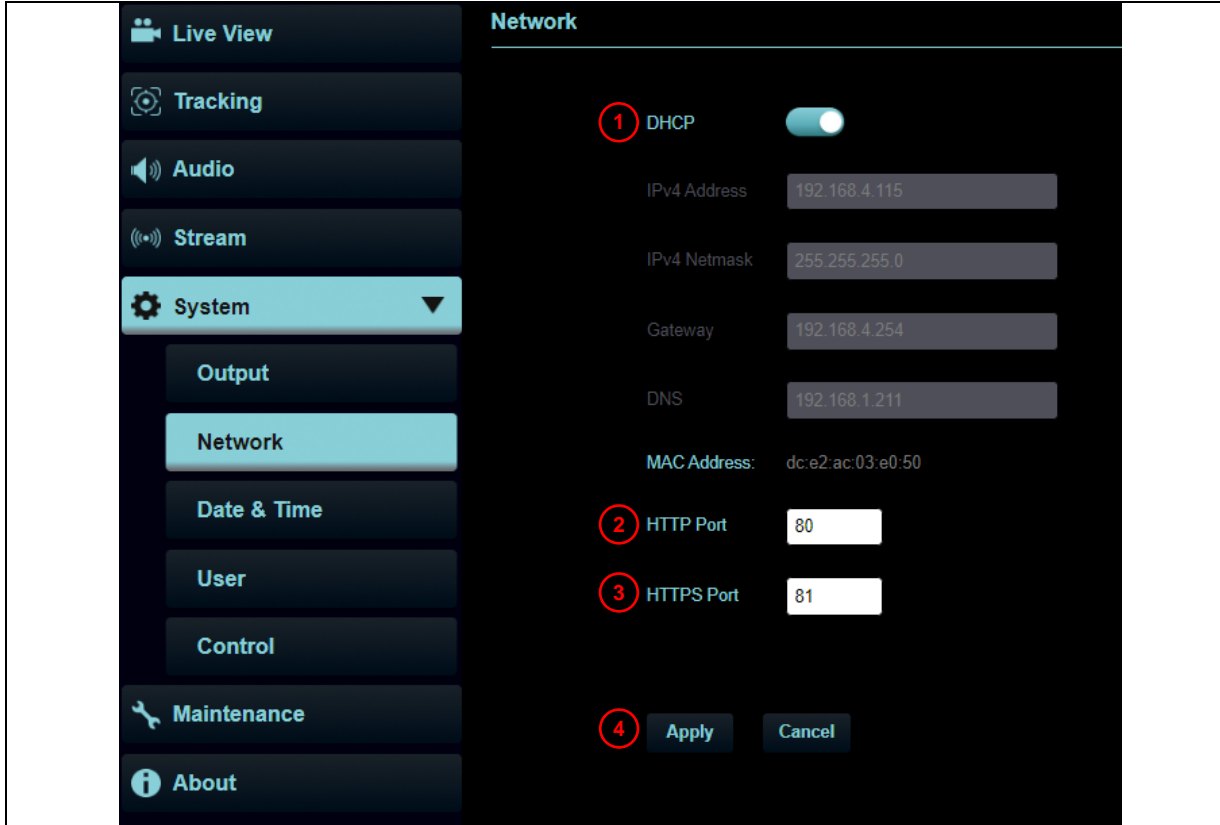

No	Item	Function Descriptions
1	DHCP	Camera network settings. Modifications can be made when DHCP is disabled.
2	HTTP Port	Set HTTP port. The default Port value is 80
3	HTTPS Port	Set HTTPS port. The default Port value is 81
4	Apply/ Cancel	Apply/ Cancel Setting

5.2.8 System - Date & Time

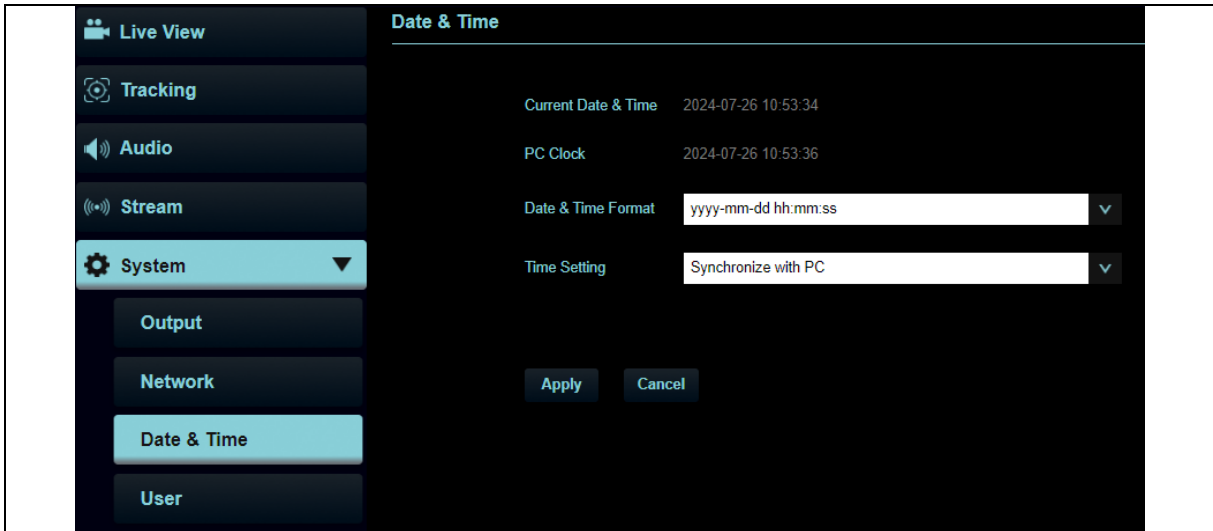

Description

Display the current camera/PC date/time, and set the display format.
Manually set [Time Settings], Date & Time or synchronize with your PC.

5.2.9 System - User

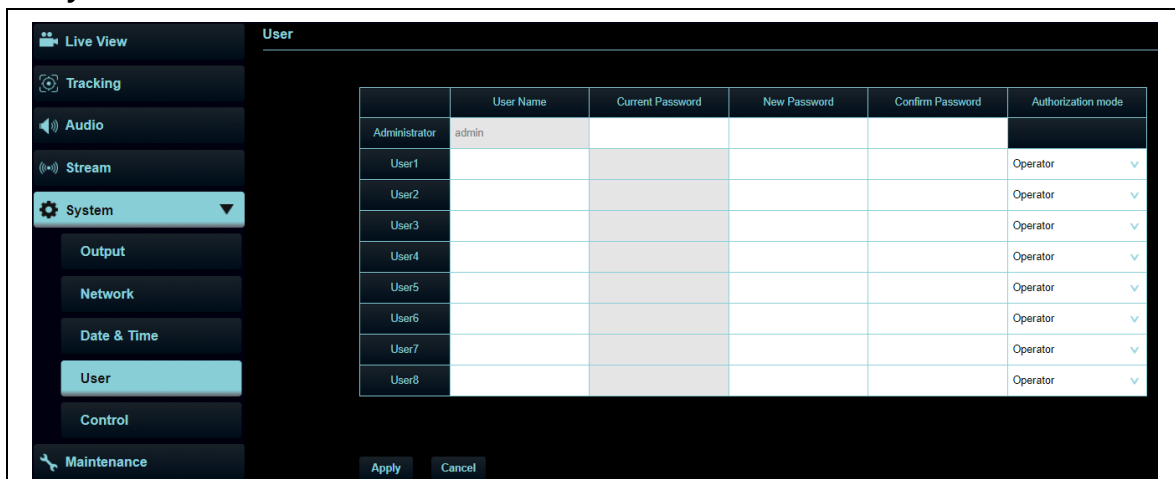

Description

Add/Modify/Delete user account

- Supports 4 - 32 characters for user name and password
- Use uppercase, lowercase letters or numbers. Special symbols cannot be used
- Account permissions:

User Type	Admin	Operator	Viewer
Live View	V	V	V
Settings	V	V	X
Account management	V	X	X

Note Performing a factory reset will clear all user data.

5.2.10 System - Control

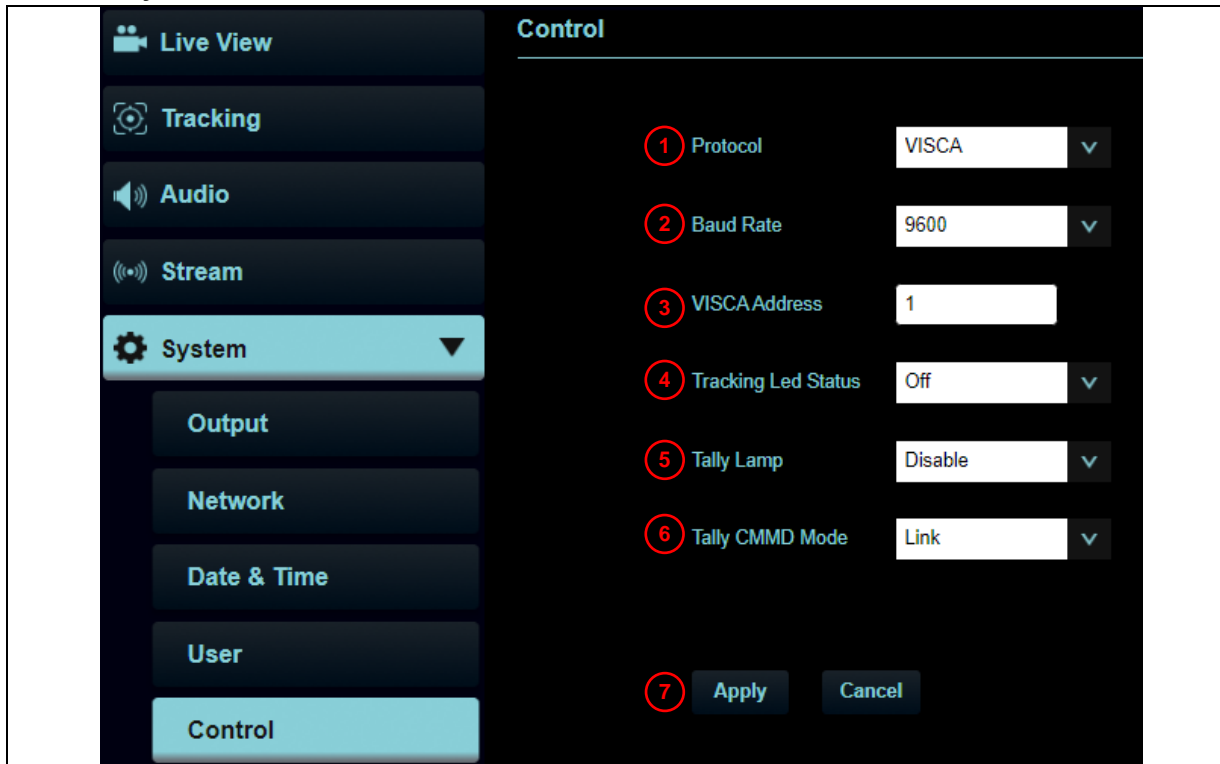

No	Item	Function Descriptions
1	Protocol	Supports VISCA protocol
2	Baud Rate	Select the transmission speed of the control signal
3	VISCA address	The camera ID address 1 ~ 7 can be assigned.
4	Tracking LED status	When enabled, LED on the front panel will flash green while the camera is tracking.
5	Tally Lamp	Enable/ disable the tally lamp.
6	Tally CMMD Mode	<p>Set whether the tally lamp is linked with RS232 commands.</p> <ul style="list-style-type: none"> ▪ Normal (Not linked): The tally lamp and mode are set separately. <ul style="list-style-type: none"> ➤ When the tally lamp is on but the default mode is off, an additional command is required to set the indicator light mode ➤ When the tally lamp is off, setting the mode will not trigger the indicator light ▪ Link: <ul style="list-style-type: none"> ➤ When the tally lamp is on, the default mode is red light ➤ When the tally lamp is off, setting the mode will turn on the tally lamp.
7	Apply/ Cancel	Apply/ Cancel Setting

5.2.11 Maintenance

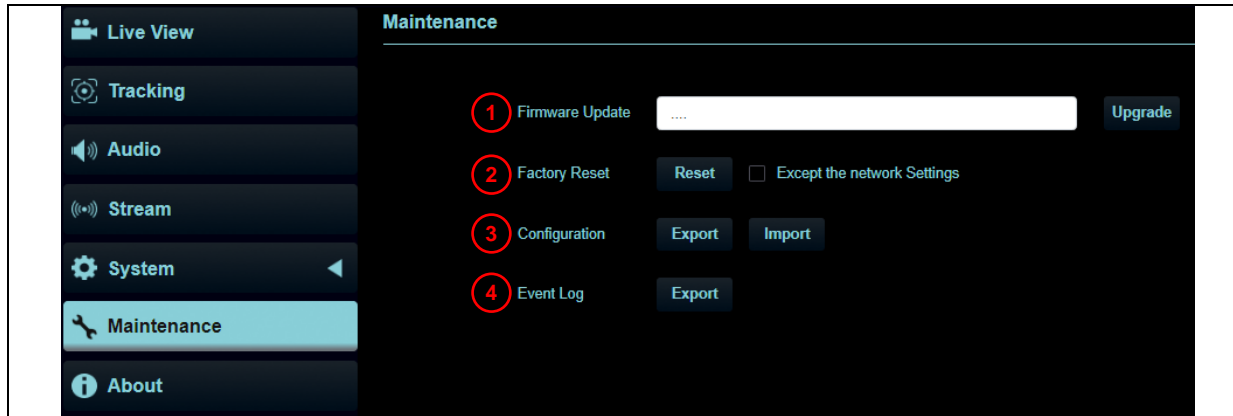

No	Item	Function Descriptions
1	Firmware Update	Click [...] to select the firmware file, and click [Upgrade] to start updating. <div style="border: 1px solid gray; padding: 2px; width: fit-content;">Note</div> <ul style="list-style-type: none"> ■ Update process takes 2-3 minutes. ■ Do not operate or turn off the power of the device during the update to avoid firmware failure.
2	Factory Reset	Reset all configurations to default settings. Check [Except the Network Setting] to keep the Network settings after reset <ul style="list-style-type: none"> ■ [Except the Network Setting] can be selected when DHCP is off
3	Configuration	Save setup parameters as a Profile, and users can download and upload camera setup parameters.
4	Event Log	If the camera operates abnormally, please export event log and provide it to Lumens for investigation.

5.2.12 About

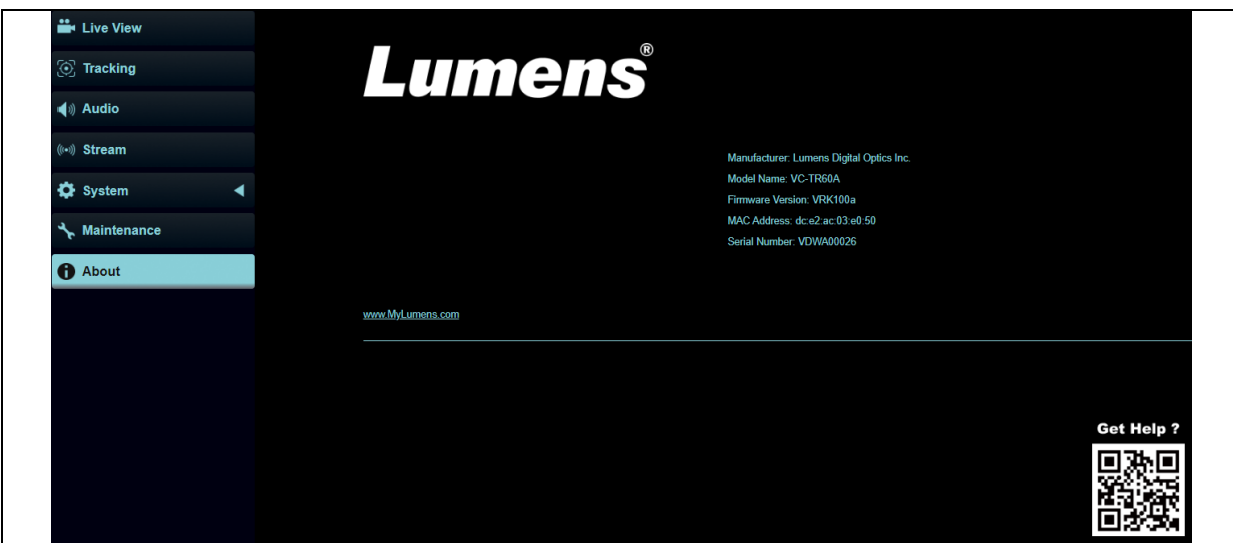

Description
Display the firmware version, serial number, and other related information of the camera For technical support, please scan the QR code at the bottom right.

Chapter 6 Troubleshooting

This chapter describes problems you may encounter while using VC-TR60A. If you have questions, please refer to related chapters and follow all the suggested solutions.

If the problem still occurs, please contact your local distributor or Lumens.

No.	Problems	Solutions
1.	No power to the device	<ol style="list-style-type: none"> 1. Make sure you have plugged in the power cord. 2. When using a PoE connection, ensure that the power supply supports PoE+ (IEEE802.3at).
2.	There is no image output from camera	<ol style="list-style-type: none"> 1. Check the power supply or PoE supply functions. 2. Confirm whether the camera resolution can be used with the connected display. <ul style="list-style-type: none"> ▪ If the camera is set to 4K resolution, output, confirm the display supports 4K output 3. Replace the cable and make sure it's not faulty.
3.	Camera image is severely delayed	Use 60/50 fps rather than 25/30 fps signals.
4.	RS-232 cannot be controlled	<ol style="list-style-type: none"> 1. Confirm the connection is correct (RS-232 In/ Out) 2. Please make sure the Baud rate setting is the same as the control device.
5.	ONVIF software cannot discover the camera	Please make sure that [System] > [Output] > [Camera ID] / [Location] in the web page uses only English letters or numbers. The ONVIF software cannot find the camera if you use special symbols or space.
6.	The camera does not save relevant parameters (PTZ, AWB ...) after reboot	<p>Please make sure if the [Initial Position] is set to [Last MEM] from the setting menu or web page</p> <ul style="list-style-type: none"> ▪ OSD Menu: [System]> [Initial Position] ▪ Web page: [Live View]> [Setting 
7.	How to log into the webpage when you forget the password	Please contact the local distributor or Lumens.

Chapter 7 Safety Instructions

Always follow these safety instructions when setting up and using PTZ Video Camera:

1 Operation

- 1.1 Please use the product in the recommended operating environment, away from water or source of heat
- 1.2 Do not place the product on an uneven surface.
- 1.3 Ensure the power plug is free of dust prior to usage. Do not insert the product's power plug into a multiplug to avoid the risk of fire.
- 1.4 Do not block the slots and openings in the case of the product. They provide ventilation and prevent the product from overheating.
- 1.5 Do not open or remove covers. It may expose you to dangerous voltages and other hazards. Refer all servicing to licensed service personnel.
- 1.6 Unplug the product from the wall outlet and refer servicing to licensed service personnel when the following situations happen:
 - If the USB port becomes damaged or frayed.
 - If liquid is spilled into the product or the product has been exposed to rain or water.

2 Installation

- 2.1 Use a mount with UL or CE safety certifications. Only technical personnel approved by your sales agent should install the device.

2.2 Storage

- 2.3 Do not place the product where the cables can be stepped on as this may result in damage to the lead or the plug.
- 2.4 Unplug the product during thunderstorms or if it is not going to be used for an extended period.
- 2.5 Do not place the product or accessories on top of vibrating equipment or heated objects.



3 Cleaning

- 3.1 Disconnect all the cables prior to cleaning. Wipe the surface with a dry cloth. Do not use alcohol or solvents for cleaning.

4 Batteries (for products or accessories with batteries)

- 4.1 When replacing batteries, please only use the same type of batteries.
- 4.2 When disposing of batteries or products, please adhere to the relevant instructions in your country or region for disposing of batteries or products.

■ Precautions

	This symbol indicates that this equipment may contain dangerous voltage which could cause electric shock. Do not remove the cover (or back). No user-serviceable parts inside. Refer servicing to licensed service personnel.		This symbol indicates that there are important operating and maintenance instructions in this User Manual with this unit.
---	---	--	---

■ FCC Warning

This equipment has been tested and found to comply with the limits for a Class A digital device, pursuant to part 15 of the FCC Rules. These limits are designed to provide reasonable protection against harmful interference when the equipment is operated in a commercial environment.

Notice :

The changes or modifications not expressly approved by the party responsible for compliance could void the user's authority to operate the equipment.

This equipment has been tested and found to comply with the limits for a Class A digital device, pursuant to part 15 of the FCC Rules. These limits are designed to provide reasonable protection against harmful interference when the equipment is operated in a commercial environment.

■ **IC Warning**

This digital apparatus does not exceed the Class A limits for radio noise emissions from digital apparatus as set out in the interference-causing equipment standard entitled “Digital Apparatus,” ICES-003 of Industry Canada.

Cet appareil numérique respecte les limites de bruits radioélectriques applicables aux appareils numériques de Classe A prescrites dans la norme sur le matériel brouilleur: “Appareils Numériques,” NMB-003 édictée par l’Industrie.

■ **EN55032 CE Warning**

Operation of this equipment in a residential environment could cause radio interference.

Warning: Operation of this equipment in a residential environment may cause radio interference

Copyright Information

Copyrights © Lumens Digital Optics Inc. All rights reserved.

Lumens is a trademark registered by Lumens Digital Optics Inc.

Copying, reproducing or transmitting this file is not allowed if a license is not provided by Lumens Digital Optics Inc. unless copying this file is for the purpose of backup after purchasing this product.

In order to keep improving the product, the information in this file is subject to change without prior notice.

To fully explain or describe how this product should be used, this manual may refer to names of other products or companies without any intention of infringement.

Disclaimer of warranties: Lumens Digital Optics Inc. is neither responsible for any possible technological, editorial errors or omissions, nor responsible for any incidental or related damages arising from providing this file, using, or operating this product.